



XTREME TACTICAL SPORTS



- OEM PARTS
- CUSTOM PARTS
- OPTICS & SIGHTS
- LASERS & FLASHLIGHTS
- ACCESSORIES
- TOOLS
- TACTICAL BAGS
- PERSONAL SECURITY

PRODUCT
CATALOG



www.dma-inc.net

TABLE OF

CONTENTS

ANODIZED PARTS, RAIL SYSTEMS, UPPERS & UPPER PARTS	2-17
SMALL PARTS, LOWER PARTS & ACCESSORIES	18-24
STOCKS, SIGHTS & GRIPS	25-30
RISERS, MOUNTS & TOOLS	31-32
MUZZLE BRAKES & THREAD PROTECTORS	33-37
OPTICS	38-44
IWB HOLSTERS	45
LASERS/FLASHLIGHTS & BORE SIGHTS	46-50
TACTICAL BAGS & VESTS	51-56
SLIDES, PARTS & TOOLS FOR GLOCK	57-61
PERSONAL SECURITY PRODUCTS	62-63

Prices may be reduced or increased without notice. Please contact your sales representative to obtain the most accurate pricing. While every effort has been made to ensure the accuracy of this catalog, descriptive, typographic, and photographic errors are subject to correction. DMA Inc. is not liable for such errors.

COMPANY BIO

About D.M.A:

The company conducts business through its centralized home office warehouse facility in Arlington, Texas U.S.A. D.M.A. Inc has been a member of the sporting goods wholesale industry since its founding in 1992. Traditionally D.M.A. has specialized in the import, export, and local distribution of high quality sporting and self defense products. From humble beginnings, D.M.A. Inc has steadily grown into one of the nations leading distributors of custom rifle accessories, knives, personal security products, and closed circuit camera Systems.

Purpose:

D.M.A.'s sole purpose is to continuously provide our customers with innovative products and uncompromising service at aggressively competitive prices.

Vision:

D.M.A. continues to grow by addressing the needs of its customers. At D.M.A. we respect the hard work and dedication that our customers put into their businesses. That is why we put our customers first and do our best to reciprocate their efforts by providing exceptional products and services with the highest emphasis on ethical business practices. It is D.M.A's sincere hope that our own hard work will earn the respect and trust of our customers in return.

Mission statement:

To become the nation's premier distributor of sporting goods by building and maintaining long term, mutually beneficial business relationships with our customers.

Core values:

D.M.A. Inc believes strongly in providing its customers with diligent service, and high quality products. We encourage growth in our employees, a strong work ethic, and insist upon honesty, integrity and business ethics at all levels. D.M.A's strict adherence to our customer first policy has brought us to where we are today.

Goals:

To increase the company's presence in the industry, while supporting the development of products and services to the firm's end consumer.



XTS-ADZ-PKSL (Silver)

XTS-ADZ-PKBR (Bronze)

XTS-ADZ-PKOD (ODG)

XTS-ADZ-PKPP (Purple)

XTS-ADZ-PKRD (Red)

XTS-ADZ-PKBL (Blue)



ANODIZED PARTS KIT

- Buffer Tube
- Charging Handle
- Forward Assist
- Ejection Port Cover
- Trigger Guard
- Ambidextrous Safety Selector
- Magazine Catch Assembly
- Allen Keys for Installation



XTS-TDP-BL, RD, PP, BR, SL, OD

Extended Takedown Pins

- Front Pivot Pin
- Rear Takedown Pin

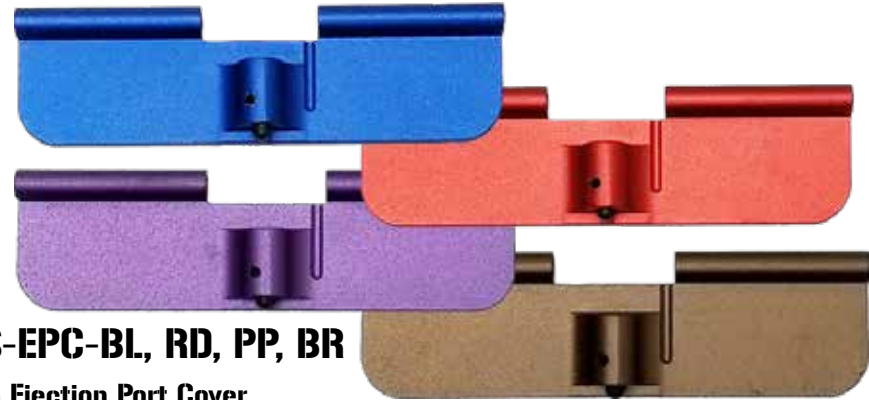

XTS-EPC-BL, RD, PP, BR

AR-15 Ejection Port Cover

- Dust Cover
- Spring
- Pin & C-clip



XTS-BC-BL, RD, PP, BR, OD, BK

AR-15 Bolt Catch Assembly

- Plunger
- Plunger Spring
- Roll pin



XTS-CH-SL, OD, BR, BL, RD, PP, OR, BK

Charging Handles

- AR-15 Mil-Spec



XTS-AWP-RD, BL, PP, BR, OD, SL, OR, BK

AR Anti-Walk Pins

- Trigger pins and Screws
- Anti-Walk Bars
- Allen Tools



XTS-XBAR-RD, BL, PP, BR, OD, BK

AR-15 Bolt Assist Release

- Bolt Assist
- Allen Tool



XTS-MCA-BL, RD, PP, BR, SL, OD, BK

AR-15 Ambi Mag Catch

- Mag Release
- Release Spring
- Allen Tool



XTS-TG-BL, RD, PP, BR

AR Trigger Guard

- Roll Pin
- Front Screw



XTS-FAA-BL, BR, PP, RD, BK

Forward Assist Assembly

- Spring
- Roll Pin



XTS-SSL-PP, BL, RD, BR, SL, OD, BK

AR Safety Selector

- Allen Tool



XTS ML2 (5 Slot)



XTS ML3 (7 Slot)



XTS ML4 (9 Slot)



(Screws & M-Lok Nuts Included)





XTS-ADZ07-RD 7" for AR-15 (Available in all 4 sizes)



XTS-ADZ10-BL 10" for AR-15 (Available in all 4 sizes)

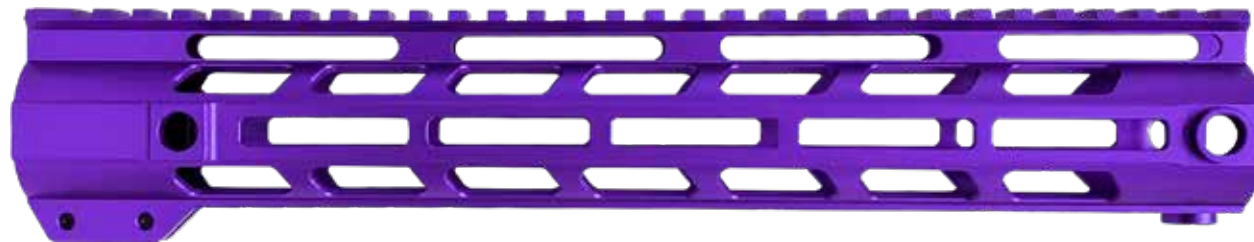

XTS-ADZ12-PP 12" for AR-15 (Available in all 4 sizes)



XTS-ADZ15-BR 15" for AR-15 (Available in all 4 sizes)

XTS AR15 Anodized M-LOK Rail Systems

- Slim, Ultra-light Free-Float Handguards with Barrel Nut
- 5 QD Swivel Slots
- Simple Clamp-on Installation



Item# Size Chart:

XTS-ADZ07(7")

XTS-ADZ10(10")

XTS-ADZ12(12")

XTS-ADZ15(15")

Item# Color Chart:

RD(Red)

BL(Blue)

PP(Purple)

BR(Bronze)

OD(OD Green)

BK(Black)

SL(Silver)



BK
(Available in all 4 sizes)

SL
(Available in all 4 sizes)

OD
(Available in all 4 sizes)



ANODIZED HANDGUARDS

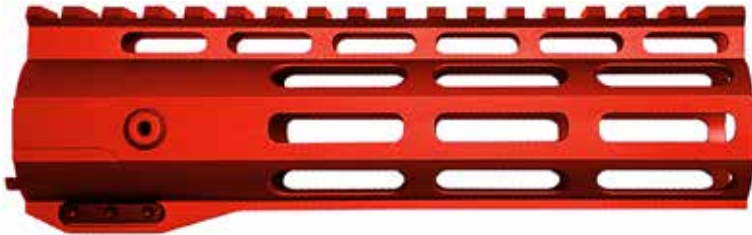

XTS-MLK07-RD 7" for AR-15

XTS AR15 Anodized M-LOK Rail Systems

- Slim, Ultra-light Free-Float Handguards with Barrel Nut
- Set Screws & Anti-Rotation Claws
- Simple Clamp-on Installation



XTS-MLK09-BL 9" for AR-15

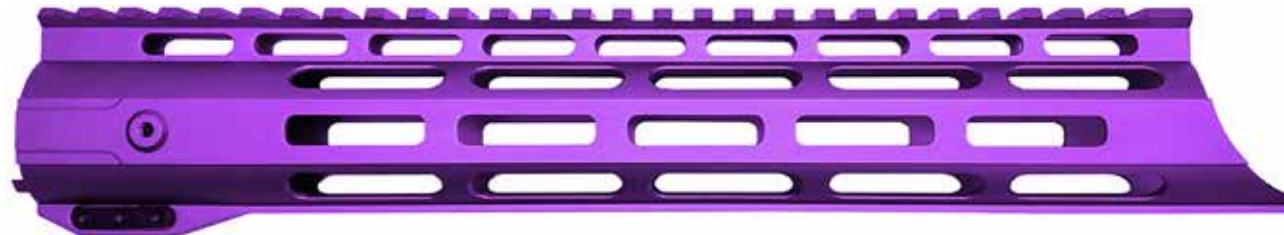

XTS-MLK12-PP 12" for AR-15



XTS-MLK15-BR 15" for AR-15

Item# Size Chart:

XTS-MLK07(7")

XTS-MLK09(9")

XTS-MLK12(12")

XTS-MLK15(15")

Item# Color Chart:

RD(Red)

BL(Blue)

PP(Purple)

BR(Bronze)



XTS-CE07ML 7" for AR-15 (Made in USA)

XTS AR15 USA M-LOK Rail Systems

- Slim, Ultra-light Free-Float Handguards with Barrel Nut
- Flat Top w/ Trapezoid Cuts
- Set Screws & Anti-Rotation Claws
- Simple Clamp-on Installation



XTS-CE09ML 9" for AR-15 (Made in USA)



XTS-CE12ML 12" for AR-15 (Made in USA)

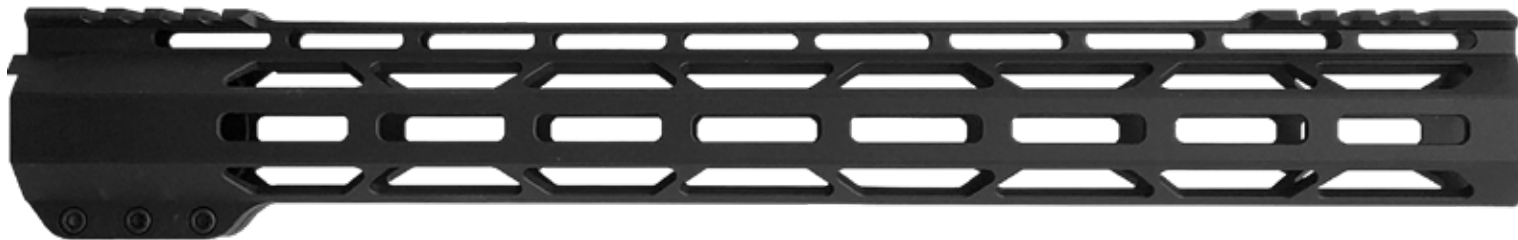

XTS-CE15ML 15" for AR-15 (Made in USA)



All
CE Rails
Come in
Retail
Packaging

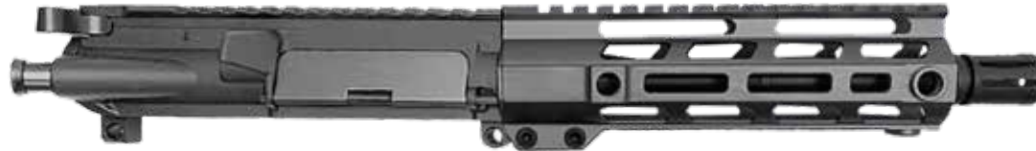

XTS-CU-7BK, BL, RD, PP, BR, OD, SL 7.5" .223/5.56 NATO (Available in all 7 Colors)

All Complete .223/5.56 Uppers Include

- .223/5.56 NATO
- Receiver
- Ejection Port Cover
- Forward Assist
- Charging Handle
- ADZ Handguard
- Barrel and Muzzle
- Gas Block & Tube



XTS-CU-10BK, BL, RD, PP, BR, OD, SL 10.5" .223/5.56 NATO (Available in all 7 Colors)



XTS-CU-12BK, BL, RD, PP, BR, OD, SL 16.5" .223/5.56 NATO (Available in all 7 Colors)



XTS-CU-16BK, BL, RD, PP, BR, OD, SL 16.5" .223/5.56 NATO (Available in all 7 Colors)

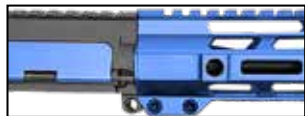

BL (Blue)



RD (Red)



PP (Purple)



BR (Bronze)



OD (Green)

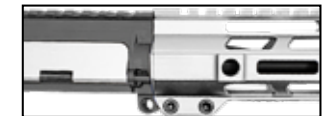

SL (Silver)

Colored Parts Include: Handguard, Ejection Port Cover, Forward Assist, Charging Handle



XTSCU8300BK, BL, RD, PP, BR, OD, SL 8.5" 300 B.O. (Available in all 7 Colors)

All Complete 300 B.O. Uppers Include

- 300 BLACK OUT
- Receiver
- Ejection Port Cover
- Forward Assist
- Charging Handle
- ADZ Handguard
- Barrel and Muzzle
- Gas Block & Tube



XTS-CUB010BK, BL, RD, PP, BR, OD, SL 10.5" 300 B.O. (Available in all 7 Colors)



XTSCU12300BK, BL, RD, PP, BR, OD, SL 16.5" 300 B.O. (Available in all 7 Colors)



XTSCU16300BK, BL, RD, PP, BR, OD, SL 16.5" 300 B.O. (Available in all 7 Colors)

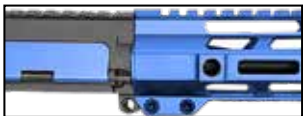

BL (Blue)



RD (Red)



PP (Purple)



BR (Bronze)



OD (Green)



SL (Silver)

Colored Parts Include: Handguard, Ejection Port Cover, Forward Assist, Charging Handle



XTSCU8300CE 8.5" 300 B.O. (USA CE Handguards)

All Complete 300 B.O. Uppers Include

- 300 BLACKOUT
- Receiver
- Ejection Port Cover
- Forward Assist
- Charging Handle
- USA CE Handguard
- Barrel and Muzzle
- Gas Block & Tube



XTS-CU-7CE 7.5" .223/5.56 NATO (USA CE Handguards)

All Complete .223/5.56 Uppers Include

- .223/5.56 NATO
- Receiver
- Ejection Port Cover
- Forward Assist
- Charging Handle
- USA CE Handguard
- Barrel and Muzzle
- Gas Block & Tube



XTS-CU-10CE 10.5" .223/5.56 NATO (USA CE Handguards)



XTS-CU-12CE 16.5" .223/5.56 NATO (USA CE Handguards)



XTS-CU-16CE 16.5" .223/5.56 NATO (USA CE Handguards)



XTS-CU-7US 7.5" .223/5.56 NATO (Stainless USA Edition)

All Complete USA Edition Uppers Include

- .223/5.56 NATO
- Receiver
- USA Flag Ejection Port Cover
- Stainless Forward Assist
- Charging Handle
- USA CE Handguard
- Barrel and SS Muzzle
- Stainless Gas Block & Tube



XTS-CU-10US 10.5" .223/5.56 NATO (Stainless USA Edition)



XTS-CU-12US 16.5" .223/5.56 NATO (Stainless USA Edition)



BCG SOLD SEPERATE - NOT INCLUDED

XTS-CU-16US 16.5" .223/5.56 NATO (Stainless USA Edition)



UPPER-S

Stripped Upper Receiver

- AR15 Upper (Accepts Multi-Cal Barrels and BCGs: .223/5.56 NATO, 300 B.O., 7.62x39, 6.5 Grendle, etc.)



UPPER

Complete Upper Receiver

- AR15 Upper (Accepts Multi-Cal Barrels and BCGs: .223/5.56 NATO, 300 B.O., 7.62x39, 6.5 Grendle, etc.)
- Forward Assist & Ejection Port Cover Included

BCG-N-308**XTS Bolt Carrier Group - AR-10/308**

- .308/7.62x51 NATO
- 9310 Steel Bolt Black Nitride
- MPI Bolt (Magnetic Particle Inspected)
- Shot Peened Bolt
- Grade 8 Hardened Fasteners
- Key Staked per Mil-Spec
- Black Extractor Insert
- Crane O-RingShot Peened Bolt

BCG-N**XTS Nickel Boron Bolt Carrier Group - AR-15/M16**

- .223/5.56 and 300 AAC
- 9310 Steel Bolt Nickel Boron
- MPI Bolt (Magnetic Particle Inspected)
- Shot Peened Bolt
- Grade 8 Hardened Fasteners
- Key Staked per Mil-Spec
- Black Extractor Insert
- Crane O-RingShot Peened Bolt

**BCG-BKN****XTS Bolt Carrier Group - AR-15/M16**

- .223/5.56 NATO/300 AAC
- 9310 Steel Bolt Black Nitride
- MPI Bolt (Magnetic Particle Inspected)
- Shot Peened Bolt
- Grade 8 Hardened Fasteners
- Key Staked per Mil-Spec
- Black Extractor Insert
- Crane O-RingShot Peened Bolt

XTS-BCG-BL**Polished Aluminum Lightweight Competition BCG - AR-15**

- .223/5.56 NATO/300 AAC
- 9310 Steel MPI Bolt
- Precision Machined
- Key Staked per Mil-Spec
- 7075 Polished Aluminum Carrier
- Anodized Finish – Blue
- Reduces recoil / increase cycle speed
- Competition Shooting Design

XTS-BCG-GD**Polished Aluminum Lightweight Competition BCG - AR-15**

- .223/5.56 NATO/300 AAC
- 9310 Steel MPI Bolt
- Precision Machined
- Key Staked per Mil-Spec
- 7075 Polished Aluminum Carrier
- Anodized Finish – Gold
- Reduces recoil / increase cycle speed
- Competition Shooting Design

XTS-BCG-RD**Polished Aluminum Lightweight Competition BCG - AR-15**

- .223/5.56 NATO/300 AAC
- 9310 Steel MPI Bolt
- Precision Machined
- Key Staked per Mil-Spec
- 7075 Polished Aluminum Carrier
- Anodized Finish – Red
- Reduces recoil / increase cycle speed
- Competition Shooting Design

XTS-BCG-PP**Polished Aluminum Lightweight Competition BCG - AR-15**

- .223/5.56 NATO/300 AAC
- 9310 Steel MPI Bolt
- Precision Machined
- Key Staked per Mil-Spec
- 7075 Polished Aluminum Carrier
- Anodized Finish – Purple
- Reduces recoil / increase cycle speed
- Competition Shooting Design

**MT021** Carbine Length for AR-15Weight:
11.435oz**XTS AR-15 2-Piece Rail Systems**

- Drop-in Handguards
- Quad Rail with Numbered Picatinny Slots
- Drops into the Delta Ring and Over the End Cap
- 4 Screws for a Secure Fit

**XTS 19M** Mid Length for AR-15Weight:
15.125oz**XTS-14AK****AK Quad Rail**

- 6061 True Aircraft Aluminum
- Hard Coat Anodized
- 3 Part Design

**XTS-15AK****AK Side Mount**

- 6061 True Aircraft Aluminum
- Hard Coat Anodized
- Easily Mounts on Side of AK

**LVB****Lower Vice Block**

- Fits AR-15 Lower Receiver

**XTS LVB10****Lower Vice Block**

- Fits AR-10 Lower Receiver

**UVB****Upper Vice Block**

- Fits AR-15 Upper Receiver

**XTS-A2****Front Sight Gas Block**

- .750 Diameter
- Available in Taper Pin or Set Screw Mounting

**FSAT****Front Sight Adjustment Tool**

- Adjust A1/A2 Front Sight Posts
- All Metal Construction
- 4 and 5 prong Ends

**DRK****Delta Ring Barrel Nut Assembly**

- Mil-Spec Assembly for AR-15/M4/M16
- Fully Assembled
- Consists of 3 Parts: Delta Ring, Snap Ring, and Weld Spring

**ENDCAP****M4 Handguard End Cap**

- .750 Inside Diameter
- Required for Use with Drop-in Handguard Systems

**BARREL** 16.5" .223/5.56 NATO 1/8**BARREL 16/3** 16.5" 300 BLACKOUT 1/8**BARREL-10** 10.5" .223/5.56 NATO 1/7**BARREL-10-30** 10.5" 300 BLACKOUT 1/8**BARREL-7** 7.5" .223/5.56 NATO 1/7**BARREL 8.5** 8.5" 300 BLACKOUT 1/8**BAR 16.308** 16.5" 300 WIN 1/10**MICRO GB .87****Low Pro Gas Block .875**

- Steel Body
- Short Profile for .875

**MICRO GB 308****Low Pro Gas Block .936**

- Short Profile for .936
- Steel Black Finish

**MICRO GBC SS****Clamp-On Low Pro Gas Block .750**

- Short Profile for .750
- Stainless Steel Finish

**MICRO AGB****Adjust. Low Pro Gas Block .750**

- Steel Body
- Short Profile for .750
- Black Oxide Finish

**XTS GB****4 Rail Gas Block .750**

- Steel Body
- Short Profile for .750
- Black Oxide Finish

AR Gas Tube

- Steel - 304 Stainless
- Stainless Steel Finish



XTS-GTFL(Full-Length)



XTS-GTIL(Intermediate-Length)



XTS-GTML(Mid-Length)



XTS-GT(Carbine-Length)



XTS-GTP(Pistol-Length)



XTS EPC-F

AR-15 Ejection Port Cover

- US Flag Dust Cover
- Spring, Pin & C-clip



XTS EPC

AR-15 Ejection Port Cover

- Dust Cover
- Spring, Pin & C-clip



XTS EPC-P

AR-15 Polymer Ejection Port Cover

- Dust Cover
- Spring, Pin & C-clip



XTS-EPC-10

AR-10 Ejection Port Cover

- Dust Cover
- Spring, Pin & C-clip



XTS-CHX

AR-15 Extended Charging Handle

- Steel Latch
- Machined Aluminum Body
- Matte Black Anodized



XTS CH-T
XTS-CH61 (6061-T6)
XTS-CH75 (7075-T6)

AR-15 Charging Handle

- Standard for AR-15
- Machined Aluminum
- Matte Black Anodized



XTS-CH10

AR-10 Charging Handle

- Standard for AR-10
- Machined Aluminum
- Matte Black Anodized



MICRO-GB
MICRO GB SS

(SS No Packaging)

Low Profile Gas Block

- .750 Diameter
- Best Used with Free Float Systems
- Dual Set Screws
- Includes Gas Tube Roll Pin





CH-EX

Charging Handle Extender

- For AR-15 and AR-10
- Ambidextrous Extender
- Spring & Roll Pin



XTS-FAA

Forward Assist Assembly

- Fits AR-15 and AR-10
- Includes Spring & Roll Pin



XTS-FAA-SS

Forward Assist Assembly

- Fits AR-15 and AR-10
- Includes Spring & Roll Pin



XTS-TDDS

Pivot & Takedown Detents & Springs

- 2 x Detent Pins
- 2 x Detent Springs



XTS-BC

Bolt Catch Assembly

- Bolt Catch
- Bolt Catch Spring
- Bolt Catch Plunger
- Bolt Catch Pin



XTS-BC-N

Bolt Catch Assembly

- Bolt Catch
- Bolt Catch Spring
- Bolt Catch Plunger
- Bolt Catch Pin



XTS-MCA

Magazine Catch Assembly

- Magazine Catch
- Magazine Catch Spring
- Magazine Release Button



XTS-MCA-SS

Magazine Catch Assembly

- Magazine Catch
- Magazine Catch Spring
- Magazine Release Button



XTS-SS

Safety Selector

- Mil-Spec
- 8620 Alloy Steel
- Black Melonite finish
- Also Compatible w/ AR10



XTS-SSL

Ambi-Safety Selector

- Mil-Spec
- 8620 Alloy Steel
- Black Melonite finish
- Also Compatible w/ AR10



XTS-BR

Buffer Retainer

- Buffer Retainer Pin
- Buffer Retainer Spring



XTS-SDS

Safety Selector Detent Pin & Spring

- 1 x Detent Pin
- 1 x Detent Spring

**TDP-SST XP****S.S. Extended Takedowns**

- Pivot & Takedown Pins
- Detents & Springs
- Tools

**TDP-SS XP****S.S. Extended Takedowns**

- Pivot & Takedown Pins
- Detents & Springs

**TDP XP****Extended Takedowns**

- Pivot & Takedown Pins
- Detents & Springs

**TDP-T XP****Extended Takedowns**

- Pivot & Takedown Pins
- Detents & Springs
- Tools

**XTS-PVP-BK****Pivot Pin**

- Mil-Spec
- 8620 Alloy Steel
- Black Melonite finish
- Fits: AR-15

**XTS-TDPS-BK****Standard Takedowns**

- Pivot & Takedown Pins
- Detents & Springs

**XTS TG****Trigger Guard**

- Enhanced Guard
- Mounting Pin & Screw

**XTS-TDP-BK****Takedown Pin**

- Mil-Spec
- 8620 Alloy Steel
- Black Melonite finish
- Fits: AR-15

**XTS-TRP-SS****Trigger & Hammer Pins**

- Mil-Spec
- Stainless steel
- Fits: AR-15

**XTS-TRGSPRNG****Trigger Spring**

- Mil-Spec

**XTS-HMRSRNG****Hammer Spring**

- Mil-Spec

**XTS-TRP-BK****Trigger & Hammer Pins**

- Mil-Spec
- Solid steel
- Matte Black finish
- Fits: AR-15

**XTS-TRG****AR Trigger**

- Mil-Spec
- Solid steel
- Matte Black finish

**XTS-HMR****AR HAMMER**

- Mil-Spec
- Solid steel
- Matte Black finish

**XTS DIS****Trigger Disconnecter**

- Mil-Spec
- Solid steel
- Matte Black finish



LOWER-PK(AR-15) LPK-308(AR-10)

Complete Lower Parts Kit - AR15/M16

- Take Down Pin
- Receiver Pivot Pin
- Take Down Pin Detents (2)
- Take Down Pin Detent Springs (2)
- Bolt Catch
- Bolt Catch Spring
- Bolt Catch Plunger
- Bolt Catch Pin
- Buffer Retainer
- Buffer Retainer Spring
- Pistol Grip
- Lock Washer
- Pistol Grip Screw
- Magazine Release Button
- Magazine Catch
- Magazine Catch Spring
- Trigger Guard Assembly
- Safety Selector
- Selector Detent
- Selector Detent Spring
- Hammer & Trigger Pin (2)
- Hammer Spring
- Trigger Spring
- Hammer
- Disconnect
- Disconnect Spring
- Trigger

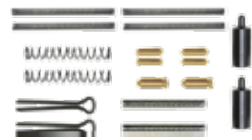

XTS-SPS XP

OOPS Kit

- Take Down Detents (4)
- Take Down Springs (4)
- Selector Detents (2)
- Selector Springs (2)
- Buffer Retainer (2)
- Retainer Springs (2)
- Firing Pin Retainin Pin (2)

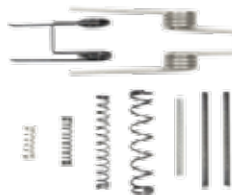

XTS-LPSK

Lower Springs Kit - AR15/M16

- Take Down Pin Detent Springs (2)
- Buffer Retainer Spring
- Hammer Spring
- Trigger Spring
- Disconnect Spring
- Bolt Catch Spring
- Magazine Catch Spring
- Selector Detent Spring



LPK-NFC(AR-15)

Lower Parts Kit No Fire Control - AR15

- Take Down Pin
- Receiver Pivot Pin
- Take Down Pin Detents (2)
- Take Down Pin Detent Springs (2)
- Bolt Catch
- Bolt Catch Spring
- Bolt Catch Plunger
- Bolt Catch Pin
- Buffer Retainer
- Buffer Retainer Spring
- Magazine Release Button
- Magazine Catch
- Magazine Catch Spring
- Trigger Guard Assembly
- Safety Selector
- Selector Detent
- Selector Detent Spring



AR KIT

Lower Springs Kit - AR15/M16

- Take Down Pin Detent Springs (2)
- Take Down Pin Detents (2)
- Buffer Retainer
- Buffer Retainer Spring
- Hammer Spring
- Trigger Spring
- Disconnect Spring
- Magazine Catch Spring
- Bolt Catch Spring
- Bolt Catch Plunger
- Bolt Catch Pin
- Hammer & Trigger Pins (2)
- Trigger Guard Pin
- Selector Detent
- Selector Detent Spring



BT-MS

Buffer Tube

- Mil-Spec
- 6- Position



CN

Castle/Lock Nut

- Steel



BT-PIS

Buffer Tube

- AR Pistol
- Foam Sleeve



BUFFER

AR15 Buffer

- Standard AR15 Buffer
- Weight: 3oz



BUFFER-HW

AR15 Buffer

- Heavy Buffer
- Weight: 4.7oz



BUFFER10

AR10 Buffer

- Standard AR10 Buffer
- Weight: 3.7oz



BSP-308

Buffer Spring .308



BSP-223

Buffer Spring .223

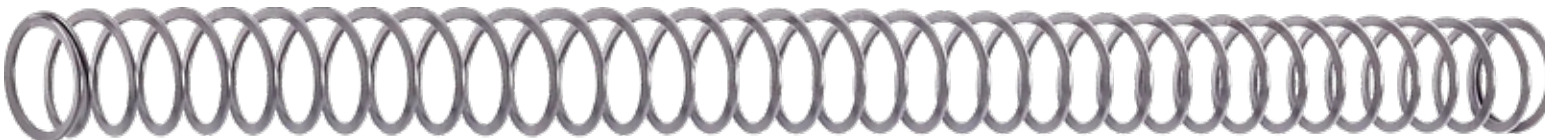

BS-F

Flat Buffer Spring .223



MT ARSTK

Complete Stock Assembly

- Standard Stock
- Mil-Spec Buffer Tube
- Castle/Lock Nut
- End Plate
- Buffer Spring
- Buffer



XTS CRSTK (Stock Only)

XTS CRSTK-A

SOPMOD Stock Assembly

- SOPMOD Stock
- Mil-Spec Buffer Tube
- Castle/Lock Nut
- End Plate
- Buffer & Buffer Spring



PM4

Stock Combat Buttpad

- Ribbed Slip-on Design
- Fits Standard 6-Position Stock



XTS-BTA-MIL

Buffer Tube Assembly

- Buffer Tube
- .223 Buffer Spring
- .223 Buffer
- Endplate
- Castle Nut





SP-4046

Slip Over Sling Adaptor

- QD Swivel
- Mounts Left or Right
- Ambidextrous Design



SP-010L

Sling Plate Adaptor

- Double Sided Loops
- Ambidextrous Design



SP-04

Sling Plate Adaptor

- QD Swivel
- Ambidextrous Design



SA-02

Picatinny Sling Adaptor

- Multi Function Sling Adaptor w/ QD Swivel



XTS-MLQDS

M-Lok Sling Adaptor

- QD Swivel w/ M-Lok Base



SA-01

Picatinny Sling Adaptor

- Picatinny Mounted Sling Adaptor



SP-05

Sling Plate Adaptor

- 180 Degree Motion
- Ambidextrous Design



SP-06

Sling Plate Adaptor

- For Use with QDS
- Ambidextrous Design



SSB-01

Sling Adaptor

- QD Swivel w/ Base



QDS

Sling Adaptor

- QD Swivel



MT020

Harris Bi-pod Adaptor

- Fits Harris-Style Bi-pods
- Sling Swivels



SL-08B(Black)

1 & 2 Point Bungee Sling

- Mounts in 1 or 2 Point Position
- Quick Release Buckles
- Includes a QD Swivel Attachment



SL-08T(FDE)



SL-08G(OD Green)



SLING-HWT(FDE)

1 Point Bungee Sling

- Quick Release Buckle



SLING-HW(Black)



SLING-HWG(OD Green)



XTS-58
XTS-58-T(FDE)

- Skeletonized Stock**
- Minimalist Style
 - Fits Mil-Spec Tubes
 - Gripped Rubber Buttpad



XTS-101
XTS-101-T(FDE)

- Skeletonized Stock**
- Minimalist Style
 - Fits Mil-Spec Tubes
 - Gripped Rubber Buttpad



XTS-105
XTS-105-T(FDE)

- Standard Stock**
- Fits Mil-Spec Tubes
 - Shock Resistant Buttpad



XTS-104

- Shock Absorbing Stock**
- Adjustable Cheek Rest
 - Fits Mil-Spec Tubes
 - Shock Absorbing Technology
 - Shock Resistant Buttpad



Same Packaging for All Stocks



XTS-106
XTS-106-T(FDE)

- Adjustable Cheek Rest Stock**
- Fits Mil-Spec Tubes
 - Shock Resistant Buttpad



XTS-301

- Rubberized Pistol Grip**
- Rubber Coated AR Grip





XTS-AKFS105T

AK Folding Stock Adaptor

- Compatible w/ most AK Rifles
- Push Button Folding
- 6 Position Tube

AK ADAPTOR COMBOS (FDE)

- Includes:**
- AK Folding Adaptor
 - Adjustable Stock



XTS-AKFS58T(FDE)

- Minimalist Style Stock FDE
- Folding Adaptor



XTS-AKFS105T(FDE)

- Standard Stock FDE
- Folding Adaptor



XTS-AKFS106T(FDE)

- Cheek Rest Stock FDE
- Folding Adaptor



XTS-AKFS58

- Standard Stock
- Folding Adaptor



XTS-AKFS101

- Standard Stock
- Folding Adaptor

AK ADAPTOR COMBOS (Black)

Includes:

- AK Folding Adaptor
- Adjustable Stock



XTS-AKFS105

- Standard Stock
- Folding Adaptor



XTS-401

Rubberized AK Pistol Grip

- Rubber Coated AK Grip



XTS-AKFS104

- Shock Absobing Stock
- Cheek Rest
- Folding Adaptor



XTS-AKFS106

- Cheek Rest Stock
- Folding Adaptor



XTS-P45FRSET 45 Offset Aluminum Flip-up Front & Rear Set

- Mounts to Picatinny Rail
- Adjustable Elevation Post
- Adjustable Windage Aperture
- Medium-Large Aperture



FRSB45 45° Angle Sights

- Machined from Lightweight and Durable Aircraft Aluminum
- Front Sight Elevation Adjustable
- Rear Sight Elevation and Windage Adjustable, with 1/2 MOA Click Value

XTS-PFRSET Aluminum Flip-up Front & Sight

- Mounts to Picatinny Rail
- Adjustable Elevation Sight Post
- Adjustable Windage Aperture
- Medium-Large Aperture



XTS-FFS XTS-FFST(FDE) Polymer Flip-up Front Sight

- Mounts to Picatinny Rail
- Adjustable Elevation Sight Post

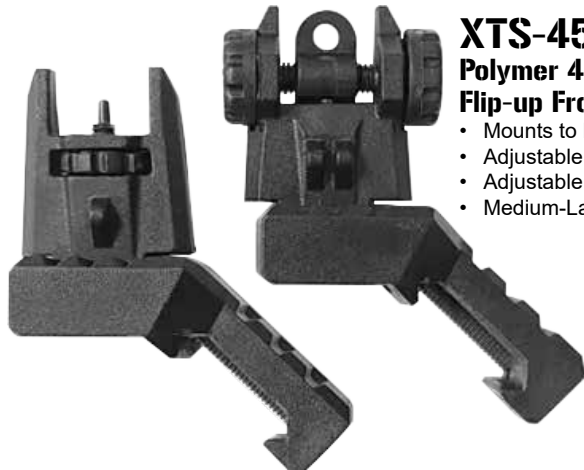

XTS-45FRPMR Polymer 45 Offset Flip-up Front & Rear Set

- Mounts to Picatinny Rail
- Adjustable Elevation Post
- Adjustable Windage Aperture
- Medium-Large Aperture



XTS-FRS XTS-FRST(FDE) Polymer Flip-up Rear Sight

- Mounts to Picatinny Rail
- Adjustable Windage Aperture
- Medium-Large Aperture





XTS 306
XTS 306T(FDE)
Short Vertical Grip

- Ribbed Texture
- Mounts to Picatinny Rail



XTS 308
XTS 308T(FDE)
Side 2 Side Folding Grip

- Grenade Style Texture
- Folds Side to Side
- Mounts to Picatinny Rail



XTS 309
XTS 309T(FDE)
Front 2 Back Folding Grip

- Grenade Style Texture
- Folds Front to Back
- Mounts to Picatinny Rail



Ribbed Vertical Foregrips

- Fits Any Rifle with a Picatinny Rail System
- Designed for Comfort and Weapon Control



AC 2019(4.5")



AC 2019-T(FDE) (4.5")



AC 2019S(3")



AC 2019S-T(FDE) (3")



GB-08
GB-08T(FDE)
Rugged Foregrip Bipod

- Finger Grooves
- Button Activated Pop-out Legs
- Pivots Side to Side





PS-F
Angle Grip
 • Mounts to Picatinny Rail



PS-FTN(FDE)
Angle Grip
 • Mounts to Picatinny Rail

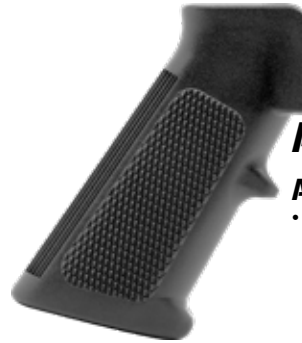

A2
A2 Grip
 • Standard AR A2 Grip



XTS-AFG-BK
M-LOK Angle Grip
 • Mounts to M-LOK Rail



XTS-AFG-TN
M-LOK Angle Grip
 • Mounts to M-LOK Rail

RETAIL PACKAGING
 (Back Only)



MT007FH
Folding Vertical Foregrip
 • 5-Position Folding
 • Combat Style Design
 • Fits Any Rifle with a Picatinny Rail System
 • Pressure Switch Slots
 • Storage Compartment



XTS-TBP
Tactical Folding Bi-Pod
 • Foldable Arms with Spring
 • Tension Control
 • Extendable Legs with Posi-Lock Wheel & Quick Retraction Button
 • Adjustable Center Height from 6.1"-7.9"
 • Extendable Leg Length from 5.5"-7.4"





MT012

1" Solid See Through Riser

- Raises Mounting Surface 1"
- 5 11/16" in Length
- CNC-Machined Aluminum



XTS 68E

1" Offset See Through Riser

- Raises Mounting Surface 1"
- 5 11/16" in Length
- CNC-Machined Aluminum



XTS 68L

1/2" Offset See Through Riser

- Raises Mounting Surface 1/2"
- 5 11/16" in Length
- CNC-Machined Aluminum



XT005

Carry Handle Adaptor

- For Mounting an Optic to an AR with a Carry Handle Top
- 5" 1/4 in Length
- CNC-Machined Aluminum



XTS-R1022TR

Top Rail for 10/22

- For Mounting an Optic to a 10/22
- 4" 5/8 in Length
- CNC-Machined Aluminum



XTS-WT8

1" See Through Riser

- Raises Mounting Surface 1"
- 8 Slots
- CNC-Machined Aluminum



MT 1011H

1" Solid See Through Riser

- Raises Mounting Surface 1"
- 3 Slots
- CNC-Machined Aluminum



XTS WS8

1/2" Riser

- Raises Mounting Surface 1/2"
- 8 Slots
- CNC-Machined Aluminum



MT 1011L

1/2" Riser

- Raises Mounting Surface 1/2"
- 3 Slots
- CNC-Machined Aluminum



XTS 45

45° Angle Mount

- Single Sided
- 4 Slots
- CNC-Machined Aluminum



**AL 1950****A2 Style Carry Handle**

- Forged from 7075 T6 Aluminum
- Mil-Spec Hard Coat Anodized
- Windage and Elevation
- Dual Apertures

**MDTRS02****Rear Detachable Sight**

- Forged from 7075 T6 Aluminum
- Mil-Spec Hard Coat Anodized
- A2 Sight Assembly is Adjustable for Windage and Elevation
- Dual Apertures

**AT 1008****AR Spanner Wrench**

- Jam Nut Wrench
- Castle Nut Wrench

**AR-W****AR Multi-Tool Wrench**

- Materials: Heat Treated Steel
- Used for: AR-15
- Weight: 18 oz
- Color: Black

**PJTW2****AR Multi-Tool Wrench**

- Materials: Steel Construction
- Used for AR-15
- Weight: 20.2 oz
- Color: Black

**RPS-PS****Roll Pin Punch Starter Set**

- 1/16 Starter Punch
- 5/64 Starter Punch
- 3/32 Starter Punch
- 1/8 Starter Punch

**RPF-PS****Roll Pin Punch Finish Set**

- 1/16 Finish Punch
- 5/64 Finish Punch
- 3/32 Finish Punch
- 1/8 Finish Punch

**BC SF-EX****Bolt Catch Roll Pin Punch Starter/Finish Set**

- One 3/32" Starter
- One 3/32" Finish

**AT 1007****AR Spanner Wrench**

- Castle Nut Wrench

**PJDRW****AR Delta Ring Wrench**

- Hand Guard Removal
- Rubber Coated Legs

**XTS-JN****1/2x28 Jam/Lock Nut**

- High Quality Steel
- Stainless Finish
- 1/2 x 28 Thread Pitch

**CW-10-223**

(10 pack)

.223 Crush Washers

- 10 Steel Crush Washers
- Black Finish

**CW-10-223 SS**

(10 pack)

.223 Crush Washers

- 10 Stainless Crush Washers
- Black Finish

**CW-10-308**

(10 pack)

.308 Crush Washers

- 10 Steel Crush Washers
- Black Finish

**CW-10-308 SS**

(10 pack)

.308 Crush Washers

- 10 Stainless Crush Washers
- Black Finish

**MZ-FSFH22S****AR Fake Silencer/Comp 1/2x28**

- CNC Machined Aluminum
- Black Anodized Finish
- 1/2 x 28 Thread
- Threads Over the Barrel

**MZ-FSFH22L****AR Fake Silencer/Comp 1/2x28**

- CNC Machined Aluminum
- Black Anodized Finish
- 1/2 x 28 Thread
- Threads Over the Barrel

**MZ-FSFH30S****AR Fake Silencer/Comp 5/8x24**

- CNC Machined Aluminum
- Black Anodized Finish
- 5/8 x 24 Thread
- Threads Over the Barrel

**MZ-FSFH30L****AR Fake Silencer/Comp 5/8x24**

- CNC Machined Aluminum
- Black Anodized Finish
- 5/8 x 24 Thread
- Threads Over the Barrel

MATTE BLACK

MZ FS223S (1/2 x 28)
Outer Diameter: 1.25"



MZ FS223M (1/2 x 28)
Outer Diameter: 1.25"



MZ FS223L (1/2 x 28)
Outer Diameter: 1.25"



MZ FS308S/MZ FS308SF (5/8 x 24)
MZ FS9S/MZ FS9SF (1/2 x 36)
Outer Diameter: 1.25"

FLAT DARK EARTH

MZ FS223SF (1/2 x 28)
Outer Diameter: 1.25"



MZ FS223MF (1/2 x 28)
Outer Diameter: 1.25"



MZ FS223LF (1/2 x 28)
Outer Diameter: 1.25"



MZ FS308M/MZ FS308MF (5/8 x 24)
MZ FS9M/MZ FS9MF (1/2 x 36)
Outer Diameter: 1.325"

OLIVE DRAB GREEN

MZ FS223SOD (1/2 x 28)
Outer Diameter: 1.25"



MZ FS223MOD (1/2 x 28)
Outer Diameter: 1.25"



MZ FS223LOD (1/2 x 28)
Outer Diameter: 1.25"



MZ FS308L/MZ FS308LF (5/8 x 24)
MZ FS9L/MZ FS9LF (1/2 x 36)
Outer Diameter: 1.325"

**MZ 1006S****AR Fake Silencer 1/2x28**

- CNC Machined Aluminum
- Black Anodized Finish
- 1/2 x 28 Thread
- Threads Over the Barrel

MZ 1006SF**AR Fake Silencer 1/2x28**

- CNC Machined Aluminum
- FDE Cerakote Finish
- 1/2 x 28 Thread
- Threads Over the Barrel

**MZ 1007S****AR Fake Silencer 5/8x24**

- CNC Machined Aluminum
- Black Anodized Finish
- 5/8 x 24 Thread
- Threads Over the Barrel

MZ 1007SF**AR Fake Silencer 5/8x24**

- CNC Machined Aluminum
- FDE Cerakote Finish
- 5/8 x 24 Thread
- Threads Over the Barrel

**MZ 1006L****AR Fake Silencer 1/2x28**

- CNC Machined Aluminum
- Black Anodized Finish
- 1/2 x 28 Thread
- Threads at the End of the Barrel

MZ 1006LF**AR Fake Silencer 1/2x28**

- CNC Machined Aluminum
- FDE Cerakote Finish
- 1/2 x 28 Thread
- Threads at the End of the Barrel

**MZ 1006ES****AR Fake Silencer 1/2x28**

- CNC Machined Aluminum
- Black Anodized Finish
- 1/2 x 28 Thread
- Threads at the End of the Barrel

**MZ 1007AK****AK Fake Silencer 14x1 LH**

- CNC Machined Aluminum
- Black Anodized Finish
- 14 x 1 LH Thread
- Threads Over the Barrel

**MZ 1018-XP22 / MZ 1018-XP30****AR Flash Cone 1/2x28**

- CNC Machined Steel
- Black Finish
- 1/2 x 28 Thread
- Sound Forwarding

AR Flash Cone 5/8x24

- CNC Machined Steel
- Black Finish
- 5/8 x 24 Thread
- Sound Forwarding



MZ 1019XP

AR Knurled Brake 1/2x28

- CNC Machined High Quality Aluminum
- Black Anodized Finish
- 1/2 x 28 Thread
- Flash Reduction



MZ 1018-223

AR Tanker Style Brake 1/2x28

- CNC Machined High Quality Aluminum
- Black Anodized Finish
- 1/2 x 28 Thread
- Flash Reduction
- Lowers Muzzle Rise



MZ 1009B

AR Comp Muzzle Brake 1/2x28

- CNC Machined High Quality Steel
- Manganese Phosphate Finish
- 1/2 x 28 Thread
- Flash Reduction
- Lowers Muzzle Rise



MZ 1010B

AR Comp Muzzle Brake 5/8x24

- CNC Machined High Quality Steel
- Manganese Phosphate Finish
- 5/8 x 24 Thread
- Flash Reduction
- Lowers Muzzle Rise



MZ 1019XP.3

AR Knurled Brake 5/8x24

- CNC Machined High Quality Aluminum
- Black Anodized Finish
- 5/8 x 24 Thread
- Flash Reduction



MZ 1018-308

AR Tanker Style Brake 5/8x24

- CNC Machined High Quality Aluminum
- Black Anodized Finish
- 5/8 x 24 Thread
- Flash Reduction
- Lowers Muzzle Rise



MZ 1009SS

AR Comp Muzzle Brake 1/2x28

- CNC Machined High Quality Steel
- Stainless Steel Finish
- 1/2 x 28 Thread
- Flash Reduction
- Lowers Muzzle Rise



MZ 1010SS

AR Comp Muzzle Brake 5/8x24

- CNC Machined High Quality Steel
- Stainless Steel Finish
- 5/8 x 24 Thread
- Flash Reduction
- Lowers Muzzle Rise

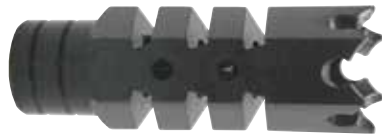

MZ 1004B

AR Shark Muzzle Brake 1/2x28

- CNC Machined High Quality Steel
- Manganese Phosphate Finish
- 1/2 x 28 Thread
- Flash Reduction
- Lowers Muzzle Rise



MZ 1004/308

AR Shark Muzzle Brake 5/8x24

- CNC Machined High Quality Steel
- Manganese Phosphate Finish
- 5/8 x 24 Thread
- Flash Reduction
- Lowers Muzzle Rise



MZ 1004SS

AR Shark Muzzle Brake 1/2x28

- CNC Machined High Quality Steel
- Stainless Steel Finish
- 1/2 x 28 Thread
- Flash Reduction
- Lowers Muzzle Rise



MZ 1004AK

AK Shark Muzzle Brake 14x1LH

- CNC Machined High Quality Steel
- Manganese Phosphate Finish
- 14 x 1 LH Thread
- Flash Reduction
- Lowers Muzzle Rise



MZ 1014AK

AK Slant Brake 14x1 LH

- CNC Machined High Quality Steel
- Manganese Phosphate Finish
- 14 x 1 LH Thread
- Flash Reduction
- Lowers Muzzle Rise



MZ 1001 MZ 1001SS

AR A2 Flash Hider 1/2x28

- CNC Machined High Quality Steel
- Manganese Phosphate Finish
- (MZ 1001SS) Stainless Steel Finish
- 1/2 x 28 Thread
- Flash Reduction & Lowers Muzzle Rise



MZ 1001308 MZ 1001308SS

AR A2 Flash Hider 5/8x24

- CNC Machined High Quality Steel
- Manganese Phosphate Finish
- (MZ 1001308SS) Stainless Steel Finish
- 5/8 x 24 Thread
- Flash Reduction & Lowers Muzzle Rise



XTS-TA

1/2x28 to 5/8x24 Thread Adaptor

- High Quality Steel
- Black Anodized Finish
- 1/2 x 28 Inner Thread to 5/8 x 24



XTS-TP

1/2x28 Thread Protector

- High Quality Steel
- Black Finish
- 1/2 x 28 Thread Pitch



XTS-TP-SS

1/2x28 Thread Protector

- High Quality Steel
- Stainless Finish
- 1/2 x 28 Thread Pitch



XTS-TP-AK

14x1LH AK Thread Protector

- High Quality Steel
- Black Finish
- 14 x 1LH Thread Pitch



XTS-TP-BK78N

5/8x24 Thread Protector

- High Quality Steel
- Knurled Black Finish
- 7/8 Outer Diameter



XTS-TP-BK82

5/8x24 Thread Protector

- High Quality Steel
- Fluted Black Finish
- .820 Outer Diameter



XTS-TP-SS82

5/8x24 Thread Protector

- High Quality Steel
- Fluted Stainless Finish
- .820 Outer Diameter



XTS-TP-BK34

5/8x24 Thread Protector

- High Quality Steel
- Fluted Black Finish
- 3/4 Outer Diameter



XTS-TP-BK78F

5/8x24 Thread Protector

- High Quality Steel
- Fluted Black Finish
- 7/8 Outer Diameter



XTS HD-4

Dual Illumination Sight

- Red/Green Illumination
- Lightweight and Compact
- 4 Reticle Styles
- Super Fast Target Acquisition With 24x34mm Window
- Integrated Weaver-style Mounting System
- CR 2032 Battery Included



XTS HD 11

Dual Illumination Sight

- Red/Green Illumination
- Lightweight and Compact
- 4 Reticle Styles
- Super Fast Target Acquisition With 24x34mm Window
- Integrated Weaver-style Mounting System
- CR 2032 Battery Included
- Red Laser with Optional Pressure Switch



XTS HD 15

Dual Illumination Sight

- Red/Green Illumination
- Lightweight and Compact
- 4 Reticle Styles
- Super Fast Target Acquisition With 24x34mm Window
- Button Activated and Adjustable Brightness
- 3 x LR754(AG5) Batteries Included
- Quick Release Weaver-style Mount



XTS HD-38

Dual Illumination Sight

- Red/Green Illumination
- Lightweight and Compact
- 4 Reticle Styles
- Super Fast Target Acquisition With 24x34mm Window
- Integrated Weaver-style Mounting System
- CR 2032 Battery Included



These Reticles are Used on the Following Models:
XTS HD-4, XTS HD-11, XTS HD-15, and XTS HD-38



Co-Witness's with SP9A3



#XTS-EDS MICRO RED DOT

- Red Illumination
- Quick Target Acquisition
- Button Activated Brightness
- Micro Footprint (RMSc Footprint)
- 1 x CR 2032 Battery Included
- 3 MOA / 1x20x28



**Fits Springfield HELLCAT
& Most Micro Pistols**

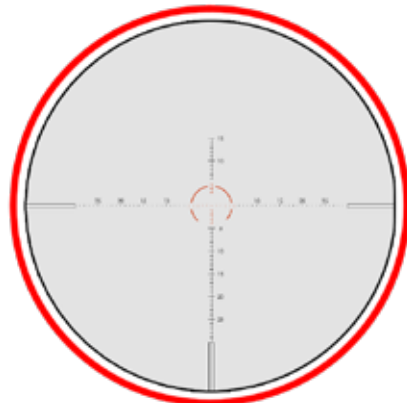

Image Shown is Springfield XDS



LENGTH	19.75"	FIELD OF VIEW @ 100YARDS	18.2'-109.2'
WEIGHT	14.9 oz.	EYE RELIEF	3.98"
TUBE SIZE	30mm	MOA @ 100YARDS	1/8"

Innovative Design and Built for *Durability*
 Nitrogen Gas Purged
 Multi-coated Optics for Image Clarity
 Extended Eye Relief for *Faster Target Acquisition*
 Waterproof, Fogproof, and Shockproof



RETICLE



#XTS-1-6X24Z

1-6x24
 30mm Tube





LENGTH	10.43"	FIELD OF VIEW @ 100YARDS	12'-118.5'
WEIGHT	23.25 oz.	EYE RELIEF	3.6"
TUBE SIZE	34mm	RRANGE	Close-Mid, 400+ Yards

Innovative Design and Built for *Durability*
 Nitrogen Gas Purged
 Multi-coated Optics for Image Clarity
 Extended Eye Relief for *Faster Target Acquisition*
 Waterproof, Fogproof, and Shockproof

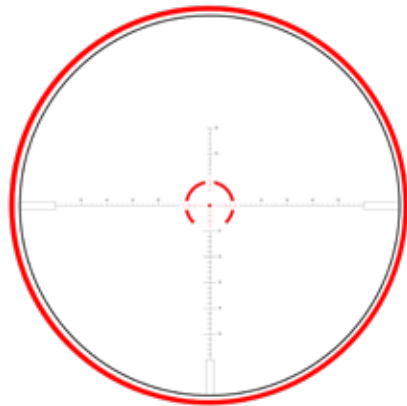

RETICLE



#XTS-1-10X28



XTS **THREE-12**
RIFLESCOPE



LENGTH	9.65"	FIELD OF VIEW @ 100YARDS	35.1'-8.7'
WEIGHT	14.9 oz.	EYE RELIEF	3.98"
TUBE SIZE	30mm	MOA @ 100YARDS	1/10"

Innovative Design and Built for *Durability*
 Nitrogen Gas Purged
 Multi-coated Optics for *Image Clarity*
 Extended Eye Relief for *Faster Target Acquisition*
 Waterproof, Fogproof, and Shockproof

3-12X44 SCOPE



RETICLE



#XTS-3-12X44



3-12X44
30mm Tube

XTS **FOUR-16**
RIFLESCOPE



LENGTH	12.205"	FIELD OF VIEW @ 100YARDS	7.96'-31.84'
WEIGHT	14.9 oz.	EYE RELIEF	1.73"
TUBE SIZE	30mm	MOA	50MOA

Innovative Design and Built for *Durability*
 Nitrogen Gas Purged
 Multi-coated Optics for *Image Clarity*
 Extended Eye Relief for *Faster Target Acquisition*
 Waterproof, Fogproof, and Shockproof



RETICLE



4-16X44

30mm Tube

#XTS-4-16X44





SIX-24

RIFLESCOPE



LENGTH	14.635"	FIELD OF VIEW @ 100YARDS	18.3'-4.6'
WEIGHT	20.8 oz.	EYE RELIEF	Approx. 4"
TUBE SIZE	30mm	MOA	50MOA

Innovative Design and Built for *Durability*
 Nitrogen Gas Purged
 Multi-coated Optics for *Image Clarity*
 Extended Eye Relief for *Faster Target Acquisition*
 Waterproof, Fogproof, and Shockproof

6-24X50 SCOPE



RETICLE



6-24X50

30mm Tube

#XTS-6-24X50





G19-2P

Glock 17/19/19X/22/23/32/33/45



G43-1P

Glock 43/43X



S&W-MP9

M&P 9 M2.0 4"



S&W-SHIELDP

M&P Shield/Shield Plus



SIG-P320

Sig P320



P365-1P

Sig P365/365X



P365 XL-1P

Sig P365XL



Belt Clip

Loosen
or
Tighten
Gun
Fit



XTS-3X

XTS-3X

Red/Green Lasers & Flashlight

- On/Off Switches
- Flashlight Modes (Solid Beam or Strobe)
- Fits Most Compact Pistols
- Windage and Elevation Adjustments
- GL and 1913 Style Mounting System
- Rechargeable Internal battery
- Includes USB-C Cable



XTS-G09

XTS-G09

Green Lasers & Flashlight

- On/Off Switches
- Flashlight Modes (Solid Beam or Strobe)
- Fits Most Compact Pistols
- Windage and Elevation Adjustments
- GL and 1913 Style Mounting System
- Rechargeable Internal battery
- Includes USB-C Cable



XTS-ML2X

XTS-ML2X

Red/Green Lasers

- On/Off Switches
- Fits Most Compact Pistols
- Windage and Elevation Adjustments
- GL and 1913 Style Mounting System
- Rechargeable Internal battery
- Includes USB-C Cable



XTS-LG

XTS-LG

Green Laser

- Ambi - On/Off Switches
- Fits Most Compact Pistols
- Windage and Elevation Adjustments
- GL and 1913 Style Mounting System
- Rechargeable Internal battery
- Includes USB-C Cable





XTS-CGLL II

XTS CGLL2

Green Laser & Flashlight

- Ambidextrous On/Off Switches
- Fits Most Compact Pistols
- Super fast target acquisition
- Windage and Elevation Adjustments
- GL and 1913 Style Mounting System
- Internal Rechargeable Battery



XTS-XLG

XTS XLG

Tactical Green Laser & Light

- 200 Lumens
- High Grade Pressure Switch
- Integrated Weaver-style Mounting System
- 2 x CR123 Battery Included



LG002

LG002

Tactical Rifle Green Laser

- Button or Pressure Switch Options
- Windage and Elevation Adjustments
- Works well with XTS-36S (Offset 1" Mount)



XT 26

Tactical Flashlight

- 1800 Lumens
- 3 Way Tail Switch to Activate Strobe & Turbo Modes
- 2600 mAh Rechargeable Battery
- Side Switch Controls 5 Illumination Levels





XTS-XLGR

XTS-XLGR

Tactical Green/Red Laser & Light

- 1200 Lumens
- High Grade Pressure Switch
- Integrated Weaver-style Mounting System
- 1 x Rechargeable Battery Included



T30R

Laser Beam Flashlight

- Cast Distance: Up to 1200 Yards
- 3 Brightness Modes, S.O.S. & Strobe
- 1 x Rechargeable Battery Included
- USB-C Charging Cable Included



FLG-2K

Flashlight/Laser Foregrip

- 2000 Lumens
- Green Laser
- 3 Brightness Modes, S.O.S. & Strobe
- 1 x Rechargeable Battery Included





XTS GX (Green Laser)

Flashlight & Laser Foregrip

- 400 Lumens
- 5 Modes
- Trigger Operated
- 3 x CR123 Batteries Included
- Integrated Weaver-style Mounting System



FLG 150

Flashlight Foregrip

- 200 Lumens
- 3 Brightness Modes, S.O.S. & Strobe
- 2 x CR123 Batteries Included
- Integrated Weaver-style Mounting System



XTS FLSC200

Sub-Compact Pistol Flashlight

- 200 Lumens
- On Switch x 2 for Strobe
- 1 x CR2 Battery Included
- Integrated Weaver-style Mounting System



XM-23

Pistol Flashlight

- 800 Lumens
- Quick Detach Mounting
- Aluminum Body
- GL or 1913 interchangeable Mounting
- Micro USB Charging
- Includes USB Cable



XTS 36S

1" Offset Flashlight/Laser Mount

- 1" Diameter
- Integrated Weaver-style Mounting System
- Includes Allen Wrench



Compatibility

GLOCK®

- G17, 19, 20, 22, 23, 25, 32

SMITH & WESSON®

- M&P® M2.0 3.6/4.25 IN.
- M&P® M2.0 FULL SIZE

SIG SAUER®

- SIG SAUER P226
- SIG SAUER P229
- SIG SAUER P320V

SMITH & WESSON®

- HK VP9 SK
- CZ P10C
- RUGER SR9

Red Laser

Bore Sights

- Wavelength: 635-655nm
- Output: <5mW



BS 7MMREM

7mm REM Mag Bore Sight

- Batteries Included



BS 7.62X39

7.62x39 Bore Sight

- Batteries Included



BS 9MM

9mm Bore Sight

- Batteries Included



BS 223REM

.223 REM/5.56 Bore Sight

- Batteries Included



BS 8MM

8mm Bore Sight

- Batteries Included



BS 30-06

.30-06/.25-06/.270 Bore Sight

- Batteries Included



BS 38357

.38/.357 Bore Sight

- Batteries Included



BS 303BR

.303 British Bore Sight

- Batteries Included



BS 3030

30-30 WIN Bore Sight

- Batteries Included



BS 20GA

20 Gauge Bore Sight

- Batteries Included



BS 40

.40 Bore Sight

- Batteries Included



BS 76254

7.62x54 Bore Sight

- Batteries Included



BS .308

.243/.308 WIN/7MM Bore Sight

- Batteries Included



BS 12GA

12 Gauge Bore Sight

- Batteries Included



BS 45

.45 Bore Sight

- Batteries Included

ML007DGN

Tactical Backpacks

- Perfect for Outdoor Use!
- Capacity: 2400 cu. in.
- Size: 19"(H) x 17"(W) x 7.5"(D)
- Multiple MOLLE style straps, Laptop Carrying Pouch in Main Compartment
- Padded Back



ML007BK



ML007TAN



ML007DM



ML007DMBK



ML007DMBRN



ML007DMTAN



ML007GRY



TL 312
(12" x 8" x 8")



TL 318
(18" x 9" x 5.5")

Tactical Backpacks

- Concealed Pistol Pocket
- Well-padded Back
- MOLLE Straps
- Head Phone Slit



SRB 101L
(16.5" x 12" x 10.5")

SRB 101
(14" x 9.5" x 9.5")

Range Bags

- 7 Main Pockets
- Well-padded Internally
- Internal Storage Compartments
- MOLLE Straps



OP 313B
OP 313DM
(13" x 6.5" x 10")



(DM)



OP 315B
OP 315DM
(15" x 8" x 12")

Field Bags

- 7 Main Compartments



TG 130 TAN
TG 130 (Black)
(30" x 14" x 12")

Tactical Bags

- #10 Heavy-Duty Zippers
- Large & Roomy Main-Compartment
- Big Front & Side Pockets for Outdoor Gear
- Molle Pocket System for Extra Options
- Convenient Size Choices from 15" - 30"



TG 126 TAN
TG 126 (Black)
(26" x 13" x 11")



TG 122TAN
TG 122 (Black)
(22" x 12" x 10")



TG 118TAN
TG 118 (Black)
(18" x 11" x 9")



TG 115 T (Tan)
TG 115 (Black)
(15" x 10" x 8")



ORC 142UMC(42")

ORC 136UMC(36")

Dual Rifle Case

- Nylon Cover Foam Divider
- Velcro Straps to hold Rifles
- Main Front Pocket with Inner Velcro Pockets
- 3 Front Pouches for Storage
- Adjustable Backpack Straps
- MOLLE Straps



ORC 142(42")

ORC 136(36")

SRC 137BLK(34" Single)



ORC 142G(42")

ORC 136GRY(36")



ORC 142DMBK(42")

ORC 136DMBK(36")

SRC 137DMBK(34" Single)



ORC 142T(42")

ORC 136T(36")

SRC 137TAN(34" Single)



SRC 137UCM(34" Single)

Single Rifle Case

- 5 Magazine Pockets
- Zipper Front Pocket for Storage
- Shoulder Strap with Padding
- US Flag Patch



XTS-TRC42BK(42")
XTS-TRC42TN(42")

XTS-TRC36BK(36")
XTS-TRC36TN(36")

Dual Rifle Case

- Nylon Cover Foam Divider
- Velcro Straps to hold Rifles
- Main Front Pocket with Inner Velcro Pockets
- 3 Front Pouches for Storage
- Adjustable Backpack Straps
- MOLLE Straps



XTS-BPSP

11.5" x 10" Plates

- Armor Level: Level III
- Stab and Slash Resistant
- Thickness: .25"
- Armor Construction Material Ballistic Steel
- Total Weight: 7.5 lbs
- Designed to be used as a front or back plate



AL 002GN(OD Green)

12" x 10.5" Chest Plate Dimensions

- Size Adjustable (Shoulder & Waist)
- MOLLE Straps
- 5 Magazine Pouches
- 2 Large Side Pouches
- Removeable Bungee Sling



AL 003CM(Black Camo)
AL 002BK(Black)
AL 002TN(FDE)

**12.5" x 13.5" Chest Plate
 Dimentions**

- Size Adjustable (Shoulder & Waist)
- MOLLE Straps
- 5 Magazine Pouches
- Chest Pouch w/ Pistol Mag Pouch
- 2 Large Side Pouches
- Removeable Bungee Sling



XTS-SAP

12.5" x 13.5" Plates

- NIJ Certified Level 3A.
- Level 3A Soft Armor Kevlar Ballistic Panels
- Includes Front and Back Removable Ballistic Panels
- Velcro Fastening System for Custom Fit
- Durable Nylon Construction
- Total Weight: 3.95 lbs

XTS-BPV(Soft Vest)

**12.5" x 13.5" Chest Plate
 Dimentions**

- Size Adjustable (Shoulder & Waist)
- Can Be Worn Concealed or On Top of Clothing



G19-SPK(Gen 3)

G19 Slide Parts Kit

- Extractor
- Extractor Depressor Plunger
- Extractor Depressor Plunger Spring
- Spring -Loaded Bearing
- Slide Cover Plate
- Firing Pin
- Spacer Sleeve
- Firing Pin Spring
- Spring Cups
- Firing Pin Safety
- Firing Pin Safety Spring
- Channel Liner
- Guide Rod and Recoil Spring Assembly

G17-SPK(Gen 3)

G17 Slide Parts Kit

- Extractor
- Extractor Depressor Plunger
- Extractor Depressor Plunger Spring
- Spring -Loaded Bearing
- Slide Cover Plate
- Firing Pin
- Spacer Sleeve
- Firing Pin Spring
- Spring Cups
- Firing Pin Safety
- Firing Pin Safety Spring
- Channel Liner
- Guide Rod and Recoil Spring Assembly

GL-LPK(Gen 3)

G19, 17, 22, 23, 32 Frame Kit

- Connector
- Slide Stop Release with Spring
- Locking Block Pin
- Magazine Release
- Magazine Release Spring
- Slide Lock
- Slide Lock Spring
- Trigger Housing Pin
- Trigger Housing with Ejector
- Trigger Pin
- Trigger Spring
- Trigger with Trigger Bar

PARTS KITS FOR GLOCK®



GLOCK® is a federally registered trademark of Glock, Inc. and is one of many trademarks owned by Glock, Inc. XTS is not affiliated with nor endorsed by Glock, Inc.

G17 BARRELS - GEN 1-4



G17-BAR G17 Crowned Barrel (Nitride)



G17-BAR-G G17 Crowned Barrel (TiN)



G17-BAR-R G17 Crowned Barrel (Chameleon)



G17-BART G17 Threaded Barrel (Nitride)



G17-BART-G G17 Threaded Barrel (TiN)



G17-BART-R G17 Threaded Barrel (Chameleon)



G19 BARRELS - GEN 1-5



G19-BAR G19/X, G45 Crowned Barrel (Nitride)



G19-BAR-G G19/X, G45 Crowned Barrel (TiN)



G19-BAR-R G19/X, G45 Crowned Barrel (Chameleon)



G19-BART G19/X, G45 Threaded Barrel (Nitride)



G19-BART-G G19/X, G45 Threaded Barrel (TiN)



G19-BART-R G19/X, G45 Threaded Barrel (Chameleon)



G19-BART-S G19/X, G45 Threaded Barrel (Stainless)

G43/43X BARRELS



G43-BAR-G G43/X Crowned Barrel (TiN)



G43-BAR-R G43/X Crowned Barrel (Chameleon)



G43-BART G43/X Threaded Barrel (Nitride)



G43-BART-G G43/X Threaded Barrel (TiN)



G43-BART-R G43/X Threaded Barrel (Chameleon)



GLOCK® is a federally registered trademark of Glock, Inc. and is one of many trademarks owned by Glock, Inc. XTS is not affiliated with nor endorsed by Glock, Inc.

TOOLS FOR GLOCK®

TS-GT8B

Glock Magwell Vice Block

- Heavy Duty Polymer
- Fits 9mm Glock Pistols, .357 Sig and .40 S&W



TS-GT43

Glock Disassembly Tool

- Punch Tool for Frame Pins



TS-GT39B

Glock Front Sight Tool

- For Installation and Removal of Glock Front Sights



G19-SLD10D
G19 Gen 3 RMR Cut
(OD Green)



G19-SLD1BR
G19 Gen 3 RMR Cut
(Midnight Bronze)



G19-SLD1GY
G19 Gen 3 RMR Cut
(Tungsten Grey)



G19-SLD1FD
G19 Gen 3 RMR Cut
(Flat Dark Earth)



G19-SLD1BK
G19 Gen 3 RMR Cut
(Graphite Black)

GLOCK® is a federally registered trademark of Glock, Inc. and is one of many trademarks owned by Glock, Inc. XTS is not affiliated with nor endorsed by Glock, Inc.

SLIDES FOR GLOCK® 19

FEATURES & SPECS

- Replaces OEM Glock 19 slide or Glock style frames
- Made from certified 17-4 stainless steel in the U.S.A
- Cerakote applied for unmatched corrosion resistance
- Fits Trijicon/Holosun - Holosun 507C X2(Tapped 6-32)
- Large windows for reduced mass and use of ported barrels



G19-SLD2FD
G19 Gen 3 RMR Cut
(Flat Dark Earth)



G19-SLD2BK
G19 Gen 3 RMR Cut
(Graphite Black)



G19-SLD2OD
G19 Gen 3 RMR Cut
(OD Green)



G19-SLD2BR
G19 Gen 3 RMR Cut
(Midnight Bronze)



G19-SLD2GY
G19 Gen 3 RMR Cut
(Tungsten Grey)



X-1502
Mini Stun Gun
Thumb Drive Style 1



X-1602
Mini Stun Gun
Thumb Drive Style 2



**ALL STUN GUNS
ARE
RECHARGEABLE**



X-2301
Mini Stun Gun
w/ Lanyard



X-1903
Mini Stun Gun
Pen Style w/ Clip



TD-511-PP
Tiger Claw Stun Gun
85 Mil Volts



TD-511-PK
Tiger Claw Stun Gun
85 Mil Volts



TD-511-BK
Tiger Claw Stun Gun
85 Mil Volts



LB-800-BK
Block Stun Gun
96 Mil Volts



OM2BK
1/2 oz Pepper Spray



CHECK OUR ONLINE INVENTORY
FOR AVAILABLE COLORS



OM 3
2 oz Pepper Spray



OM 4
3 oz Pepper Spray



OM 5
3 oz Pepper Spray



OM 6
4 oz Pepper Spray



OM 9
9 oz Pepper Spray
"Bear Deflector"



NS 16
16" Telescopic
Baton

NS 21
21" Telescopic
Baton

NS 26
26" Telescopic
Baton



NS 16PK
16" Telescopic
Baton

NS 21PK
21" Telescopic
Baton

NS 26PK
26" Telescopic
Baton



4471L
14oz Leather Billy Club



4471W
9oz Leather Billy Club



BJL
11" Leather Slapper



BJS
8.25" Leather Slapper

4471L	63	BT-PIS	21	GB-08	29	MZ 1010B	36	OP 315B	52	TD-511-PP	62
4471W	63	BUFFER	21	GB-08T	29	MZ 1010SS	36	OP 315DM	52	TDP XP	19
A2	30	BUFFER10	21	GL-LPK	57	MZ 1014AK	37	ORC 136	54	TDP-SS XP	19
AC 2019	29	BUFFER-HW	21	LB-800-BK	62	MZ 1018-223	36	ORC 136DMBK	54	TDP-SST XP	19
AC 2019S	29	CH-EX	18	LG002	47	MZ 1018-308	36	ORC 136GRY	54	TDP-T XP	19
AC 2019S-T	29	CN	21	LOWER-PK	20	MZ 1018-XP22	35	ORC 136T	54	TG 115	53
AC 2019-T	29	CW-10223	33	LPK-308	20	MZ 1018-XP30	35	ORC 136UMC	54	TG 115 T	53
AL 002BK	56	CW-10-223 SS	33	LPK-NFC	20	MZ 1019XP	36	ORC 142	54	TG 118	53
AL 002GN	55	CW-10-308	33	LVB	15	MZ 1019XP.3	36	ORC 142DMBK	54	TG 118TAN	53
AL 002TN	56	CW-10-308 SS	33	MTRS02	32	MZ FS223L	34	ORC 142G	54	TG 122	53
AL 003CM	56	DRK	15	MICRO AGB	16	MZ FS223LF	34	ORC 142T	54	TG 122TAN	53
AL 1950	32	ENDCAP	15	MICRO GB .87	16	MZ FS223LOD	34	ORC 142UMC	54	TG 126	53
AR KIT	20	FLG 150	49	MICRO GB SS	17	MZ FS223M	34	P365 XL-1P	45	TG 126 TAN	53
AR-W	32	FLG-2K	48	MICRO GBC SS	16	MZ FS223MF	34	P365-1P	45	TG 130	53
AT 1007	32	FRSB45	28	MICRO-GB	17	MZ FS223MOD	34	PJDRW	32	TG 130 TAN	53
AT 1008	32	FSAT	15	ML007BK	51	MZ FS223S	34	PJTW2	32	TL 312	52
BAR 16.308	16	G17-BAR	58	ML007DGN	51	MZ FS223SF	34	PM4	22	TL 318	52
BARREL	16	G17-BAR-G	58	ML007DM	51	MZ FS223SOD	34	PS-F	30	TS-GT39B	59
BARREL 16/3	16	G17-BAR-R	58	ML007DMBK	51	MZ FS308L	34	PS-FTN	30	TS-GT43	59
BARREL 8.5	16	G17-BART	58	ML007DMBRN	51	MZ FS308LF	34	QDS	23	TS-GT8B	59
BARREL-10	16	G17-BART-G	58	ML007DMTAN	51	MZ FS308M	34	RPF-PS	32	UPPER	13
BARREL-10-30	16	G17-BART-R	58	ML007GRY	51	MZ FS308MF	34	RPS-PS	32	UPPER-S	13
BARREL-7	16	G17-SPK	57	ML007TAN	51	MZ FS308S	34	S&W-MP9	45	UVB	15
BC SF-EX	32	G19-2P	45	MT 1011H	31	MZ FS308SF	34	S&W-SHIELDP	45	X-1502	62
BCG-BKN	14	G19-BAR	58	MT 1011L	31	MZ FS9L	34	SA-01	23	X-1602	62
BCG-N	14	G19-BAR-G	58	MT ARSTK	22	MZ FS9LF	34	SA-02	23	X-1903	62
BCG-N-308	14	G19-BAR-R	58	MT007FH	30	MZ FS9M	34	SIG-P320	45	X-2301	62
BJL	63	G19-BART	58	MT012	31	MZ FS9MF	34	SL-08B	24	XM-23	49
BJS	63	G19-BART-G	58	MT020	23	MZ FS9S	34	SL-08G	24	XT 26	47
BS .308	50	G19-BART-R	58	MT021	15	MZ FS9SF	34	SL-08T	24	XT005	31
BS 12GA	50	G19-BART-S	58	MZ 1001	37	MZ-FSFH22L	33	SLING-HW	24	XTS 19M	15
BS 20GA	50	G19-SLD1BK	60	MZ 1001308	37	MZ-FSFH22S	33	SLING-HWG	24	XTS 306	29
BS 223REM	50	G19-SLD1BR	60	MZ 1001308SS	37	MZ-FSFH30L	33	SLING-HWT	24	XTS 306T	29
BS 30-06	50	G19-SLD1FD	60	MZ 1001SS	37	MZ-FSFH30S	33	SP-01OL	23	XTS 308	29
BS 3030	50	G19-SLD1GY	60	MZ 1004/308	36	NS 16	63	SP-04	23	XTS 308T	29
BS 303BR	50	G19-SLD1OD	60	MZ 1004AK	36	NS 16PK	63	SP-05	23	XTS 309	29
BS 38357	50	G19-SLD2BK	61	MZ 1004B	36	NS 21	63	SP-06	23	XTS 309T	29
BS 40	50	G19-SLD2BR	61	MZ 1004SS	36	NS 21PK	63	SP-4046	23	XTS 36S	49
BS 45	50	G19-SLD2FD	61	MZ 1006ES	35	NS 26	63	SRB 101	52	XTS 45	31
BS 7.62X39	50	G19-SLD2GY	61	MZ 1006L	35	NS 26PK	63	SRB 101L	52	XTS 68E	31
BS 76254	50	G19-SLD2OD	61	MZ 1006LF	35	OM 3	63	SRC 137BLK	54	XTS 68L	31
BS 7MMREM	50	G19-SPK	57	MZ 1006S	35	OM 4	63	SRC 137DMBK	54	XTS CGLL2	47
BS 8MM	50	G43-1P	45	MZ 1006SF	35	OM 5	63	SRC 137TAN	54	XTS CH	17
BS 9MM	50	G43-BAR-G	59	MZ 1007AK	35	OM 6	63	SRC 137UCM	54	XTS CH-T	17
BS-F	21	G43-BAR-R	59	MZ 1007S	35	OM 9	63	SSB-01	23	XTS CRSTK	22
BSP-223	21	G43-BART	59	MZ 1007SF	35	OM2BK	63	T30R	48	XTS CRSTK-A	22
BSP-308	21	G43-BART-G	59	MZ 1009B	36	OP 313B	52	TD-511-BK	62	XTS DIS	19
BT-MS	21	G43-BART-R	59	MZ 1009SS	36	OP 313DM	52	TD-511-PK	62	XTS EPC	17

XTS EPC-F	17	XTS-ADZ10-RD	6	XTS-BCG-RD	14	XTS-CU16300OD	11	XTS-FRST	28	XTS-SSL-BK	5
XTS EPC-P	17	XTS-ADZ10-SL	7	XTS-BC-N	18	XTS-CU16300PP	11	XTS-G09	46	XTS-SSL-BL	5
XTS FLSC200	49	XTS-ADZ12-BK	7	XTS-BC-OD	3	XTS-CU16300SL	11	XTS-GT	17	XTS-SSL-BR	5
XTS GB	16	XTS-ADZ12-BL	6	XTS-BC-PP	3	XTS-CU-16BK	10	XTS-GTFL	17	XTS-SSL-OD	5
XTS GX	49	XTS-ADZ12-BR	6	XTS-BC-RD	3	XTS-CU-16BL	10	XTS-GTIL	17	XTS-SSL-PP	5
XTS HD 11	38	XTS-ADZ12-OD	7	XTS-BPSP	55	XTS-CU-16BR	10	XTS-GTML	17	XTS-SSL-RD	5
XTS HD 15	38	XTS-ADZ12-PP	6	XTS-BPV	56	XTS-CU-16CE	12	XTS-GTP	17	XTS-SSL-SL	5
XTS HD-38	38	XTS-ADZ12-RD	6	XTS-BR	18	XTS-CU-16OD	10	XTS-HMR	19	XTS-TA	37
XTS HD-4	38	XTS-ADZ12-SL	7	XTS-BTA-MIL	22	XTS-CU-16PP	10	XTS-HMRSRNG	19	XTS-TBP	30
XTS LVB10	15	XTS-ADZ15-BK	7	XTS-CE07ML	9	XTS-CU-16SL	10	XTS-JN	33	XTS-TDDS	18
XTS ML2	5	XTS-ADZ15-BL	6	XTS-CE09ML	9	XTS-CU-16US	13	XTS-LG	46	XTS-TDP-BK	19
XTS ML3	5	XTS-ADZ15-BR	6	XTS-CE12ML	9	XTS-CU-7BK	10	XTS-LPSK	20	XTS-TDP-BL	3
XTS ML4	5	XTS-ADZ15-OD	7	XTS-CE15ML	9	XTS-CU-7BL	10	XTS-MCA	18	XTS-TDP-BR	3
XTS TG	19	XTS-ADZ15-PP	6	XTS-CH10	17	XTS-CU-7BR	10	XTS-MCA-BK	4	XTS-TDP-OD	3
XTS WS8	31	XTS-ADZ15-RD	6	XTS-CH-BK	3	XTS-CU-7CE	12	XTS-MCA-BL	4	XTS-TDP-PP	3
XTS XLG	47	XTS-ADZ15-SL	7	XTS-CH-BL	3	XTS-CU-7OD	10	XTS-MCA-BR	4	XTS-TDP-RD	3
XTS-101	25	XTS-ADZ-PKBL	2	XTS-CH-BR	3	XTS-CU-7PP	10	XTS-MCA-OD	4	XTS-TDPS-BK	19
XTS-101T	25	XTS-ADZ-PKBR	2	XTS-CH-OD	3	XTS-CU-7SL	10	XTS-MCA-PP	4	XTS-TDP-SL	3
XTS-104	25	XTS-ADZ-PKOD	2	XTS-CH-OR	3	XTS-CU-7US	13	XTS-MCA-RD	4	XTS-TG-BL	5
XTS-105	25	XTS-ADZ-PKPP	2	XTS-CH-PP	3	XTS-CU8300BK	11	XTS-MCA-SL	4	XTS-TG-BR	5
XTS-105-T	25	XTS-ADZ-PKRD	2	XTS-CH-RD	3	XTS-CU8300BL	11	XTS-MCA-SS	18	XTS-TG-PP	5
XTS-106	25	XTS-ADZ-PKSL	2	XTS-CH-SL	3	XTS-CU8300BR	11	XTS-ML2X	46	XTS-TG-RD	5
XTS-106-T	25	XTS-AFG-BK	30	XTS-CHX	17	XTSCU8300CE	12	XTS-MLK07-BL	8	XTS-TP	37
XTS-1-10X28	41	XTS-AFG-TN	30	XTS-CU-10BK	10	XTS-CU8300OD	11	XTS-MLK07-BR	8	XTS-TP-AK	37
XTS-14AK	15	XTS-AKFSA	26	XTS-CU-10BL	10	XTS-CU8300PP	11	XTS-MLK07-PP	8	XTS-TP-BK34	37
XTS-15AK	15	XTS-AKFSA101	27	XTS-CU-10BR	10	XTS-CU8300SL	11	XTS-MLK07-RD	8	XTS-TP-BK78F	37
XTS-1-6X24Z	40	XTS-AKFSA104	27	XTS-CU-10CE	12	XTS-CUBO10BK	11	XTS-MLK09-BL	8	XTS-TP-BK78N	37
XTS-301	25	XTS-AKFSA105	27	XTS-CU-10OD	10	XTS-CUBO10BL	11	XTS-MLK09-BR	8	XTS-TP-BK82	37
XTS-3-12X44	42	XTS-AKFSA105T	26	XTS-CU-10PP	10	XTS-CUBO10BR	11	XTS-MLK09-PP	8	XTS-TP-SS	37
XTS-3X	46	XTS-AKFSA106	27	XTS-CU-10SL	10	XTS-CUBO10OD	11	XTS-MLK09-RD	8	XTS-TP-SS82	37
XTS-4-16X44	43	XTS-AKFSA106T	26	XTS-CU-10US	13	XTS-CUBO10PP	11	XTS-MLK12-BL	8	XTS-TRC36BK	55
XTS-45FRPMR	28	XTS-AKFSA58	27	XTS-CU12300BK	11	XTS-CUBO10SL	11	XTS-MLK12-BR	8	XTS-TRC36TN	55
XTS-58	25	XTS-AKFSA58T	26	XTS-CU12300BL	11	XTS-EDS	39	XTS-MLK12-PP	8	XTS-TRC42BK	55
XTS-58-T	25	XTS-AWP-BK	4	XTS-CU12300BR	11	XTS-EPC-10	17	XTS-MLK12-RD	8	XTS-TRC42TN	55
XTS-6-24X50	44	XTS-AWP-BL	4	XTS-CU12300OD	11	XTS-EPC-BL	3	XTS-MLK15-BL	8	XTS-TRG	19
XTS-A2	15	XTS-AWP-BR	4	XTS-CU12300PP	11	XTS-EPC-BR	3	XTS-MLK15-BR	8	XTS-TRGSRNG	19
XTS-ADZ07-BK	7	XTS-AWP-OD	4	XTS-CU12300SL	11	XTS-EPC-PP	3	XTS-MLK15-PP	8	XTS-TRP-BK	19
XTS-ADZ07-BL	6	XTS-AWP-OR	4	XTS-CU-12BK	10	XTS-EPC-RD	3	XTS-MLK15-RD	8	XTS-TRP-SS	19
XTS-ADZ07-BR	6	XTS-AWP-PP	4	XTS-CU-12BL	10	XTS-FAA	18	XTS-MLQDS	23	XTS-WT8	31
XTS-ADZ07-OD	7	XTS-AWP-RD	4	XTS-CU-12BR	10	XTS-FAA-BK	5	XTS-P45FRSET	28	XTS-XBAR-BK	4
XTS-ADZ07-PP	6	XTS-AWP-SL	4	XTS-CU-12CE	12	XTS-FAA-BL	5	XTS-PFRSET	28	XTS-XBAR-BL	4
XTS-ADZ07-RD	6	XTS-BC	18	XTS-CU-12OD	10	XTS-FAA-BR	5	XTS-PVP-BK	19	XTS-XBAR-BR	4
XTS-ADZ07-SL	7	XTS-BC-BK	3	XTS-CU-12PP	10	XTS-FAA-PP	5	XTS-R1022TR	31	XTS-XBAR-OD	4
XTS-ADZ10-BK	7	XTS-BC-BL	3	XTS-CU-12SL	10	XTS-FAA-RD	5	XTS-SAP	56	XTS-XBAR-PP	4
XTS-ADZ10-BL	6	XTS-BC-BR	3	XTS-CU-12US	13	XTS-FAA-SS	18	XTS-SDS	18	XTS-XBAR-RD	4
XTS-ADZ10-BR	6	XTS-BCG-BL	14	XTS-CU16300BK	11	XTS-FFS	28	XTS-SPS XP	20	XTS-XLGR	48
XTS-ADZ10-OD	7	XTS-BCG-GD	14	XTS-CU16300BL	11	XTS-FFST	28	XTS-SS	18		
XTS-ADZ10-PP	6	XTS-BCG-PP	14	XTS-CU16300BR	11	XTS-FRS	28	XTS-SSL	18		

POLICY INFO

SHIPPING

All orders are shipped United Parcel Service unless previously specified. Shipping prices are set by the courier and determined by the weight and size of the package. *Please note*, some of our merchandise is oversized and requires oversized packaging, please consider this when evaluating your freight charges. We charge a \$3.00 handling fee on every order. C.O.D. orders will incur an additional charge from the courier service on every box included in the shipment. Orders are usually shipped within 24 hours from the date that the order is placed. A fifteen percent restocking fee will be applied to all shipments that are refused by the recipient. The customer will also be held liable and billed for any freight charges incurred due to returned, or refused shipments. Always verify your ship to address when placing your order.

DAMAGED PACKAGES

We do our best to make sure your package arrives in excellent condition. Unfortunately, sometimes merchandise arrives damaged. We cannot be held responsible for losses or damage sustained during transit. All shipments will be insured for the value of the contents inside the box. Damage claims must be made within 72 hours after receiving your order. In the event that you need to make a claim you must contact our customer service department at 1(800) 337-2466, we will then begin the claims process for you. Our couriers require that the originating shipper file all claims. Damage claims usually take between 5 and 7 business days to process. Approved claims will be issued to you in the form of a credit on your account. No credit will be issued until the courier has approved the claim.

NON DAMAGED RETURNS

Contact one of our customer service representatives for a returned merchandise authorization number (RMA). You may then return any unused item within 7 days for a full refund of the purchased price. We regret that shipping costs are non refundable unless the item was shipped to you by our mistake. Returned merchandise must be sent to us prepaid; we cannot accept freight collect shipments. *Please note*, all returned merchandise must be saleable in the original carton with all the packing materials included. You will need to enclose your invoice number and a copy of the RMA number for all returns. Returns that arrive without an RMA number will be refused and returned at the cost of the sender. All refunds & exchanges are subject to the final approval of our quality control division. For your protection, please use United Parcel Service or insured parcel post when returning merchandise. We do not accept returns on spray weapons or electronic products unless they have factory defects. Please send your insured prepaid package to: DMA, Inc. 3015 E. Randol Mill Rd Arlington, TX 76011.



GUN PARTS

PEPPER BLOC[®]
PEPPER SPRAY

PREDATOR
BLOW GUNS

SHOCK BLOC
STUN GUNS

3015 E. Randol Mill Rd. • Arlington Texas 76011

sales@dma-inc.net • www.dma-inc.net

Ph: 817.633.6123 • Fax: 817.633.2153 • Toll Free: 800.337.2466